

Service Manual

Colour Television

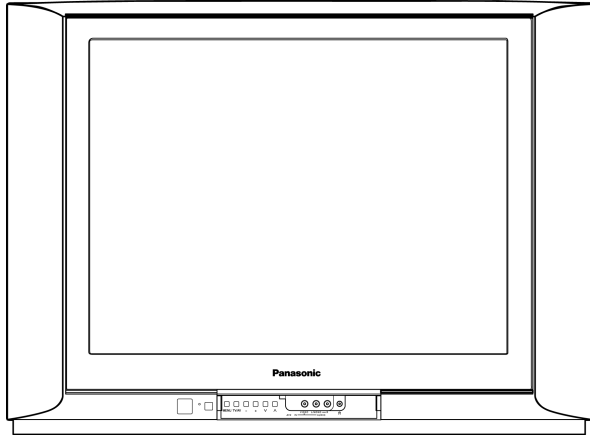

TX-21FX20RSF-IRAN

GP41 Chassis

Specifications

Power Source :	AC SINGLE 220-240V, 50/60 Hz	Audio Terminal :	AV 1, 2, YUV, MONITOR OUT
Power Consumption :	67W	RAV In	Video In 1 Vp-p 75Ω
Aerial Impedance :	75Ω unbalanced	Monitor Out	Audio In Approx. 400mVrms
	Coaxial type		Video Out 1 Vp-p 75Ω
Receiving System :	17 Systems		Audio Out Approx. 400mVrms
Receiving Channels :		High Voltage :	27.5kV ±1.5
VHF	2-12 PAL / SECAM B,K1		at zero beam current
	0-12 PAL B (N ZEALAND)	Picture Tube :	A51LYZ295X
	1-9 PAL B (N ZEALAND)		50.5cm (21 inches)
	1-12 PAL / SECAM D		Measured diagonally,
	1-12 NTSC M (JAPAN)		90° deflection
	2-13 NTSC M (U.S.A)	Audio Output :	16.0W
UHF	21-69 PAL G,H,I / SECAM G.K.KI	Dimensions :	Height : 472 mm
	28-69 PAL B (Australia)		Width : 648 mm
	13-57 PAL D,K		Depth : 488 mm
	13-62 NTSC M (JAPAN)	Mass :	24 kg (Net Wt.)
	14-69 NTSC M (U.S.A)		
CATV	S1-S20 (OSCAR)		
	1-125 (U.S.A CATV)		
	C13-C49 (JAPAN)		
	21-237 (CHINA)		
	5A,9A (AUSTRALIA)		

Specifications are subject to change without notice.
Mass and dimensions shown are approximate.

⚠ WARNING

This service information is designed for experienced repair technicians only and is not designed for use by the general public. It does not contain warnings or cautions to advise non-technical individuals of potential dangers in attempting to service a product. Products powered by electricity should be serviced or repaired only by experienced professional technicians. Any attempt to service or repair the product or products dealt with in this service information by anyone else could result in serious injury or death.

CONTENTS

	Page		Page
1 Safety Precautions	3	2.4. Adjustment for CRT CUT OFF	7
1.1. General Guide Lines	3	2.5. Adjustment Procedure	8
1.2. Leakage Current Cold Check	3	2.6. Adjustment	9
1.3. Leakage Current Hot Check (Fig. 1)	3	3 Conductor Views	12
1.4. X-Radiation	3	4 Schematic Diagram	13
1.5. GP41 Chassis Block Diagram	4	4.1. A Board	15
2 Service Hints	5	4.2. L Board	20
2.1. Service Position for E-Board	5	5 Parts Locations	23
2.2. Factory Mode Adjustment	5	6 Replacement Parts List	24
2.3. Adjustment for White Balance	7	6.1. Replacement Parts List	25

1 Safety Precautions

1.1. General Guide Lines

1. It is advisable to insert an isolation transformer in the AC supply before servicing this hot chassis.
2. When servicing, observe the original lead dress, especially the lead dress in the high voltage circuits. If a short circuit is found, replace all parts which have been overheated or damaged by the short circuit.
3. After servicing, see to it that all the protective devices such as insulation barriers, insulation papers, shields and isolation R-C combinations, are properly installed.
4. When the receiver is not to be used for a long period of time, unplug the power cord from the AC cord outlet.
5. Potential, as high as **29.0kV** is present when this receiver is in operation. Operation of the receiver without the rear cover involves the danger of a shock hazard from the receiver power supply. Servicing should not be attempted by anyone who is not thoroughly familiar with the precautions necessary when working on high voltage equipment. Always discharge the anode of the picture tube to the receiver chassis before handling the tube. After servicing make the following leakage current checks to prevent the customer from being exposed to shock hazards.

1.2. Leakage Current Cold Check

1. Unplug the AC cord and connect a jumper between the two prongs on the plug.
2. Turn on the receiver's power switch.
Measure the resistance value, with an ohmmeter, between the jumper AC plug and each exposed metallic cabinet part on the receiver, such as screw heads, aerials, connectors, control shafts, etc. When the exposed metallic part has a return path to the chassis, the reading should be between 4 M Ω and 20 M Ω . When the exposed metal does not have a return path to the chassis, the reading must be infinite.

1.3. Leakage Current Hot Check (Fig. 1)

1. Plug the AC cord directly into the AC outlet. Do not use an isolation transformer for this check.
2. Check a 2 k Ω non-inductive resistor and an AC/DC current meter, in series with each exposed metallic part on the receiver in turn and an earth such as a water pipe.

The current from any point should not exceed 0.7 mA peak AC or 2 mA DC. In the case of a measurement being outside of these limits specified, there is a possibility of a shock hazard and the receiver should be repaired and rechecked before it is returned to the customer.

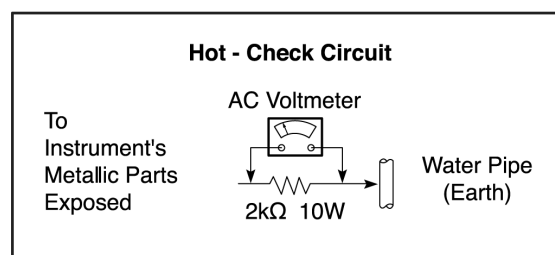

Fig. 1

1.4. X-Radiation

Warning:

The potential sources of X-Radiation in TV set are the EHT section and the picture tube. When using a picture tube test jig for service, ensure that jig is capable of handling **29.0kV** without causing X-Radiation.

Note: It is important to use an accurate periodically calibrated high voltage meter.

1. Set the brightness to minimum.
2. Use the remocon to get into Service Mode.
3. Measure the EHT. The meter reading should indicate **27.5 \pm 1.5kV**. If the meter indication is out of tolerance, immediate service and correction is required to prevent the possibility of premature component failure.
4. To prevent the possibility X-Radiation, it is essential to use the specified picture tube, if service replacement becomes necessary.

1.5. GP41 Chassis Block Diagram

GP41 CHASSIS BLOCK DIAGRAM

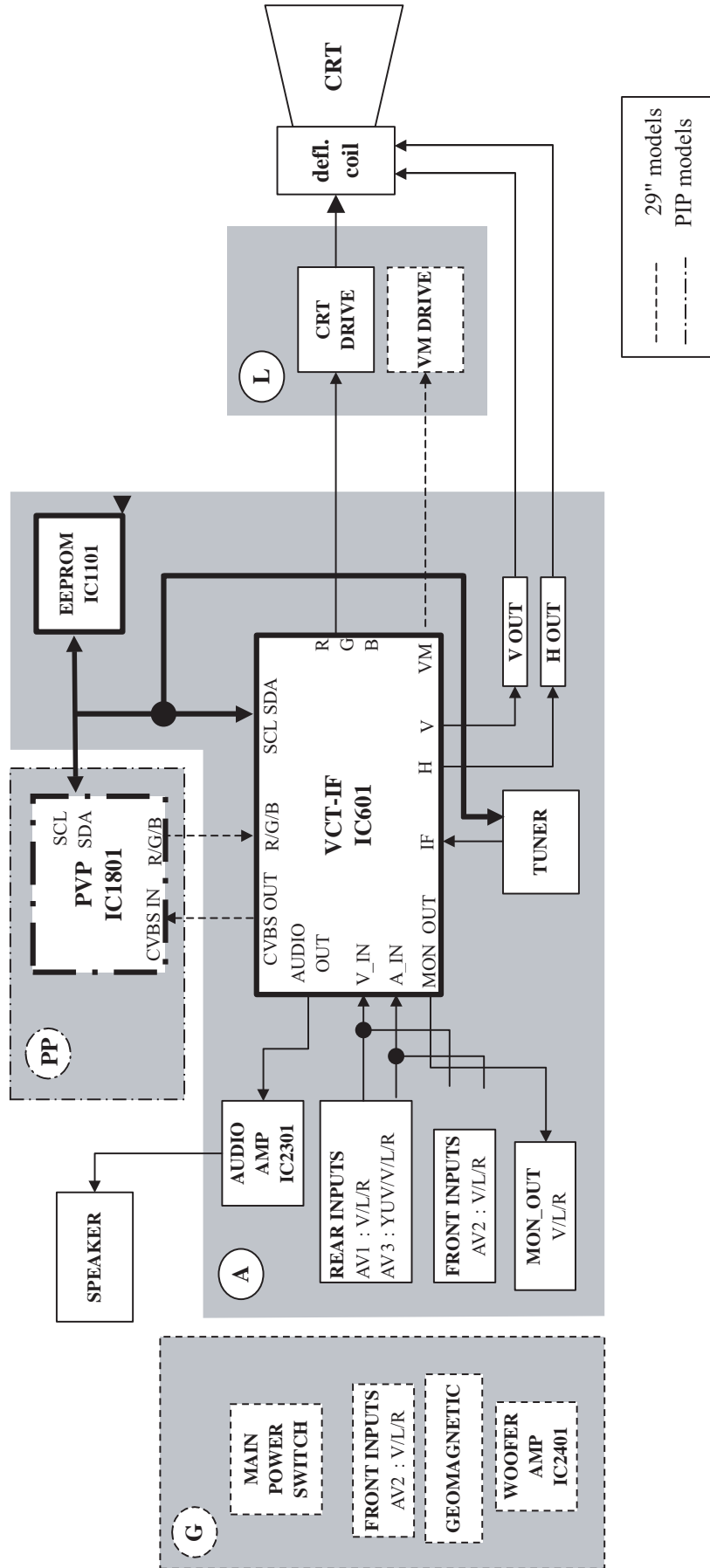

2 Service Hints

2.1. Service Position for E-Board

1. Remove the back cover.
2. Stand the TV set as shown in Fig. 2.
3. Remove the A-Board from the TV set by pulling the main board out as shown in Figure 2.

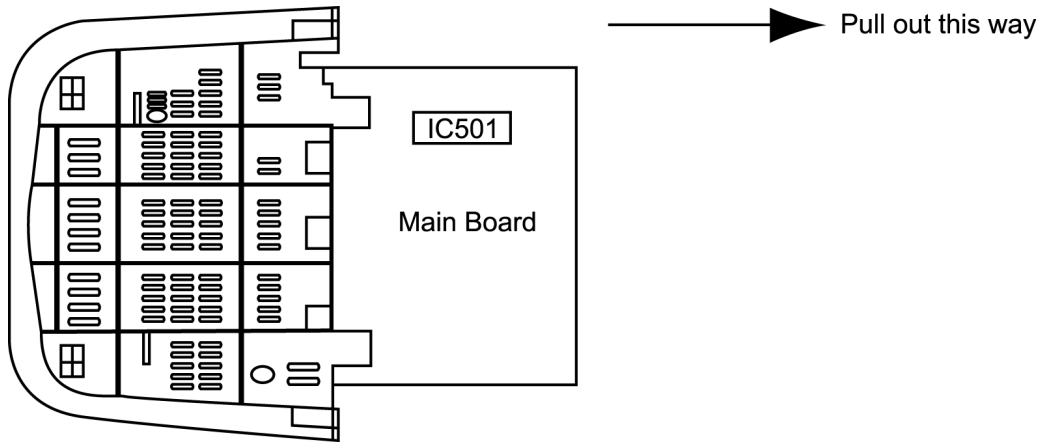

Fig. 2

2.2. Factory Mode Adjustment

1. Factory Mode Adjustment.
 - a) Set timer ON
 - b) Press remote's RECALL (\oplus) and panel's volume down key simultaneously to enter SERVICE 1.
2. To Set Self-Check:

Press the volume down button on TV then press the Off Timer Button on remote control.
3. Service Mode 1 Controls

Key 3/4	Previous/Next Service 1 Item
Key 8/9	Adjust user Brightness(-/+)
Program up/down	Program position up/down
Volume +	Increment of selected item
Volume -	Decrement of selected item
OK	Store/Save selected item
Normalize	Exit service mode

4. Service Mode 1 Function

No.	Alignment	Range
1	H-POS	-128~127
2	V-POS	-128~127
3	V-AMP	-128~127
4	DVCO	-
5	R-CUT OFF	0~511
6	G-CUT OFF	242
7	B-CUT OFF	0~511
8	R-DRIVE	0~511
9	G-DRIVE	N / A
10	B-DRIVE	0~511
11	SUB-Bright	-128~127

5. Service Mode 2 Controls

To enter SERVICE 2; press channel key '1' in SERVICE 1 entry screen.

Key 3/4	Previous/Next Service 2 Item
Key 8/9	Toggle for option bit 0-7
Program up/down	Program position up/down
Volume +	Increment of selected item
Volume –	Decrement of selected item
OK	Store/Save selected item
Normalize	Exit service mode

NOTE :- Service mode 2 options bit.

6. Service Mode 3 Controls

To enter SERVICE 3; press channel key '1' in SERVICE 2 entry screen.

Key 3/4	Previous/Next Service 1 Item
Program up/down	Program position up/down
Volume +	Increment of selected item
Volume –	Decrement of selected item
OK	Store/Save selected item
Normalize	Exit service mode

7. Service Mode 3 Function

No.	Alignment	Range
1	H-POS 60Hz Offs	-128~127
2	V-POS 60Hz Offs	-128~127
3	V-AMP 60Hz Offs	-128~127
4	V-LIN	-128~127
5	V-SYM	-128~127
6	ANGLE	-128~127
7	BOW	-128~127
8	V-ZOOM	0~511

2.3. Adjustment for White Balance

Preparation:

1. Receive the white balance pattern and aging should have been performed over 30 minutes.
2. Set the picture menu to DYNAMIC NORMAL.
3. Degauss the CRT face.
4. Fix the CRT colour analyzer receiver unit to CRT face.

Adjustment of Low Light.

1. Adjustment Sub Bright, so that $Y = 6.5 \pm 1.0$ nit.
2. Adjustment R-CUT OFF, so that $X = 0.245 \pm 0.015$ nit.
3. Adjustment G-CUT OFF, so that $Y = 0.274 \pm 0.015$ nit.

Adjustment of High Light

1. Adjustment Sub Bright, so that $Y = 150$ nit.
2. Adjustment R-Drive, so that $X = 0.261 \pm 0.015$ nit.
3. Adjustment B-Drive, so that $Y = 0.274 \pm 0.015$ nit.

2.4. Adjustment for CRT CUT OFF

Preparation:

1. Connect the oscilloscope probe to TPL5.
2. Screen VR min.
3. Set the data Sub Bright, Bright.
4. In service Mode at "Bright" dac press [5] in factory mode to enter vertical line and adjust by volume down or up button.
5. Adjust "Screen VR" until 1-H Line appears.

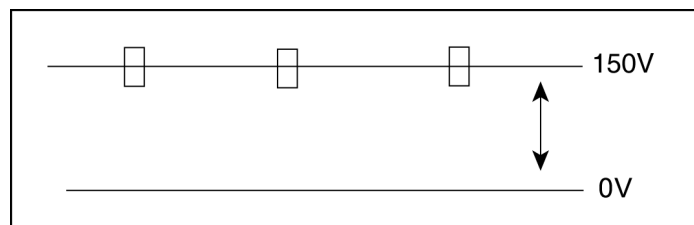

2.5. Adjustment Procedure

2.5.1. +B Voltage

Item / preparation

1. Operate the TV set.
2. Set control as follows :
Brightness minimum
Contrast minimum

Adjustment procedure

1. Confirm the DC voltage at the indicated test points, as follows :
TPA 15 : $3.35 \pm 0.2V$
TPA 16 : $141 \pm 2V$
TPA 17 : $8.2 \pm 0.5V$
TPA 18 : $1.9 \pm 0.2V$
TPA 19 : $5.2 \pm 0.2V$
TPA 20 : $175 \pm 15V$

2.5.2. High Voltage

Item / preparation

1. Receive the crosshatch pattern.
2. Set to 0 Beam.
Screen VR minimum
Contrast minimum

Adjustment procedure

1. Connect a DC voltage meter to TPA 16 and confirm the +B voltage is $141.0 \pm 2V$.
2. Connect a high frequency voltmeter to heater and confirm that voltage reads 6.3 ± 0.24 (VRMS).
3. Normalize the brightness and contrast.

2.6. Adjustment

Before Colour Purity, Convergence and White Balance adjustment are attempted, V. Height, H. Centre and Focus adjustments must be completed.

Colour Purity

1. Set the Brightness and Contrast controls to their maximum positions.
2. Operate the TV set for 60 minutes.
3. Fully degauss the picture tube by using an external degaussing coil.
4. Apply a crosshatch pattern signal and adjust the static convergence magnets to the approximately correct position.
5. Receive a black and white signal.
6. Set the control as follows:
Red.....minimum
Green.....minimum
Blue.....minimum
Press the Shipping button on the remote control twice to select CRT Adjustment Mode to select low light.
7. Loosen the clamp screw for the Deflection Yoke A in Fig. 10 and move the Deflection Yoke as close to the purity magnet as possible.
8. Adjust the purity magnetic rings so that a vertical green field is obtained at the centre of the screen.

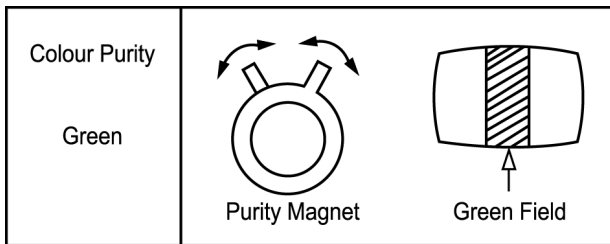

Fig. 6

9. Slowly push the Deflection Yoke and set it where a uniform green field is obtained.

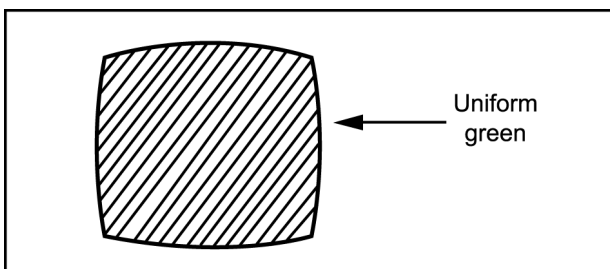

Fig. 21

10. Re-adjust the Low Light controls to their correct settings and make sure that a uniform white field is obtained.
11. Tighten the clamp screw A in Fig. 10.

Convergence

1. Apply a crosshatch pattern signal and Normalize Contrast control to the maximum positions.
2. Adjust Brightness until the grey position of the crosshatch pattern just becomes black.
3. Adjust the Red and Blue line at the centre of the screen by rotating the R-B static.

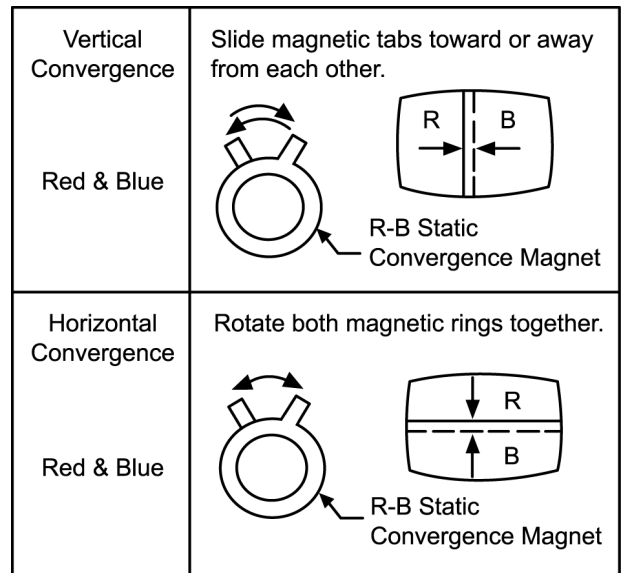

Fig. 8

4. Adjust Red and Blue with Green line at centre of the screen by rotating (RB)-G static convergence magnetic rings.
5. Lock convergence magnets with silicone sealer.
6. Remove the DY wedges and slightly tilt the Deflection Yoke vertically and horizontally to obtain the good overall convergence.

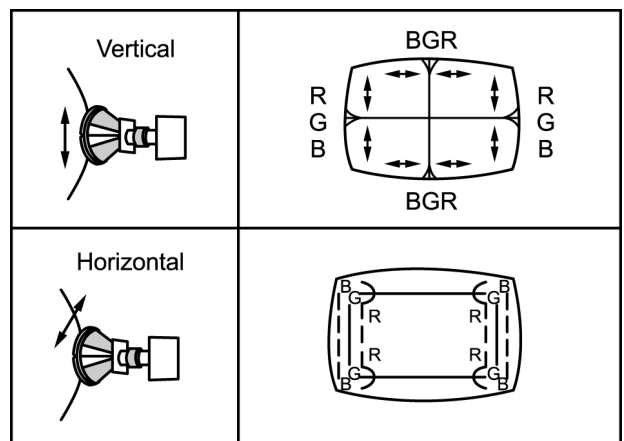

Fig. 9

7. Fix the Deflection Yoke by reinserting the DY wedges. Refer to Fig. 10.
8. If purity error is found, repeat "Colour Purity" adjustment.

Adjustment of CRT VRS

1. Preparation

- a. Set DY to CRT not to tilt up and down left and right deflection.
- b. Set CY to CRT and set CY magnet primarily (Fig. 1)
 - Purity magnet : Set purity magnet that 2 magnets are (TOP POSITION)
 - VRS magnet : Set purity magnet 2 magnets are (HORIZONTAL POSITION)

2. Adjustment

- a. Receive that Cross Hatch pattern.
- b. Adjust V-SHIFT -50Hz.
- c. Set 2 magnets of horizontal position to up and down equally so that it will be the center part of CRT. (Fig. 2)

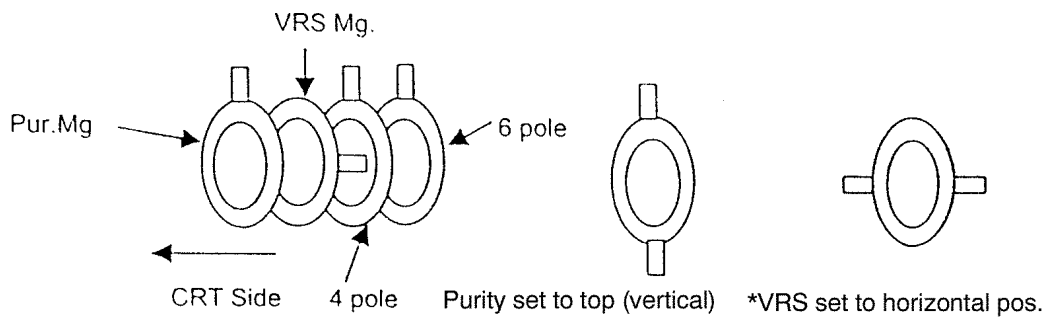
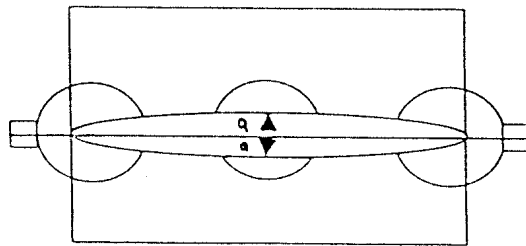

FIG 1.



$$a \leq 0 \pm 1\text{mm}$$

FIG 2.

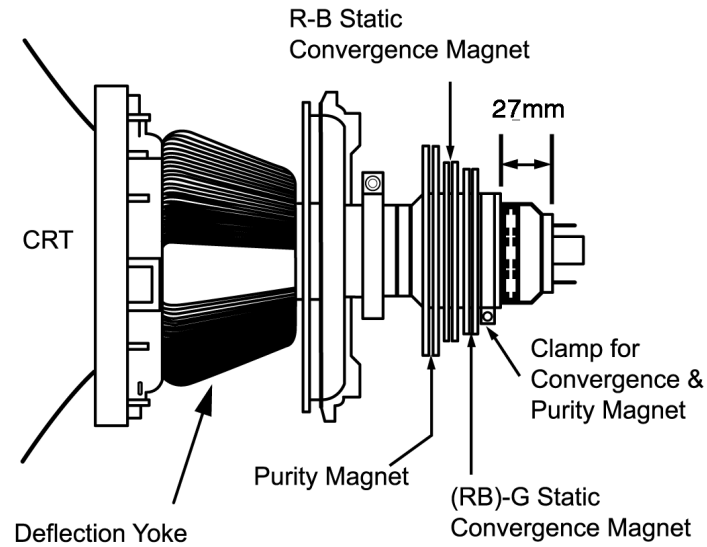

Fig. 10

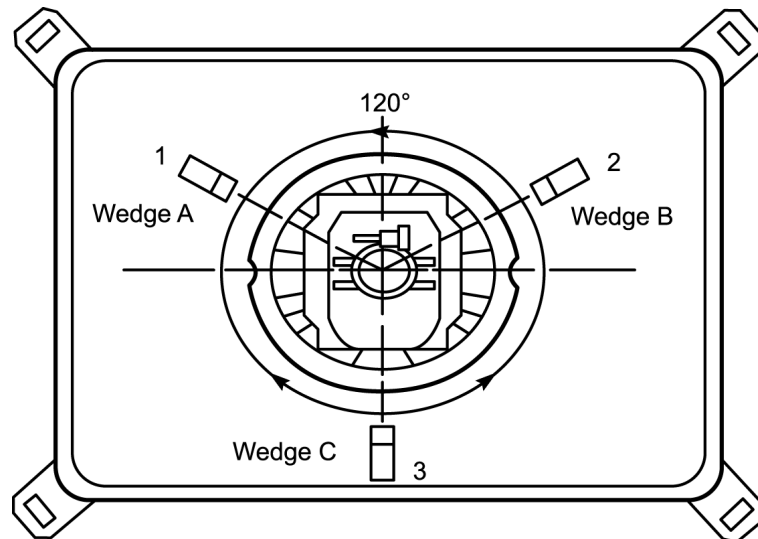
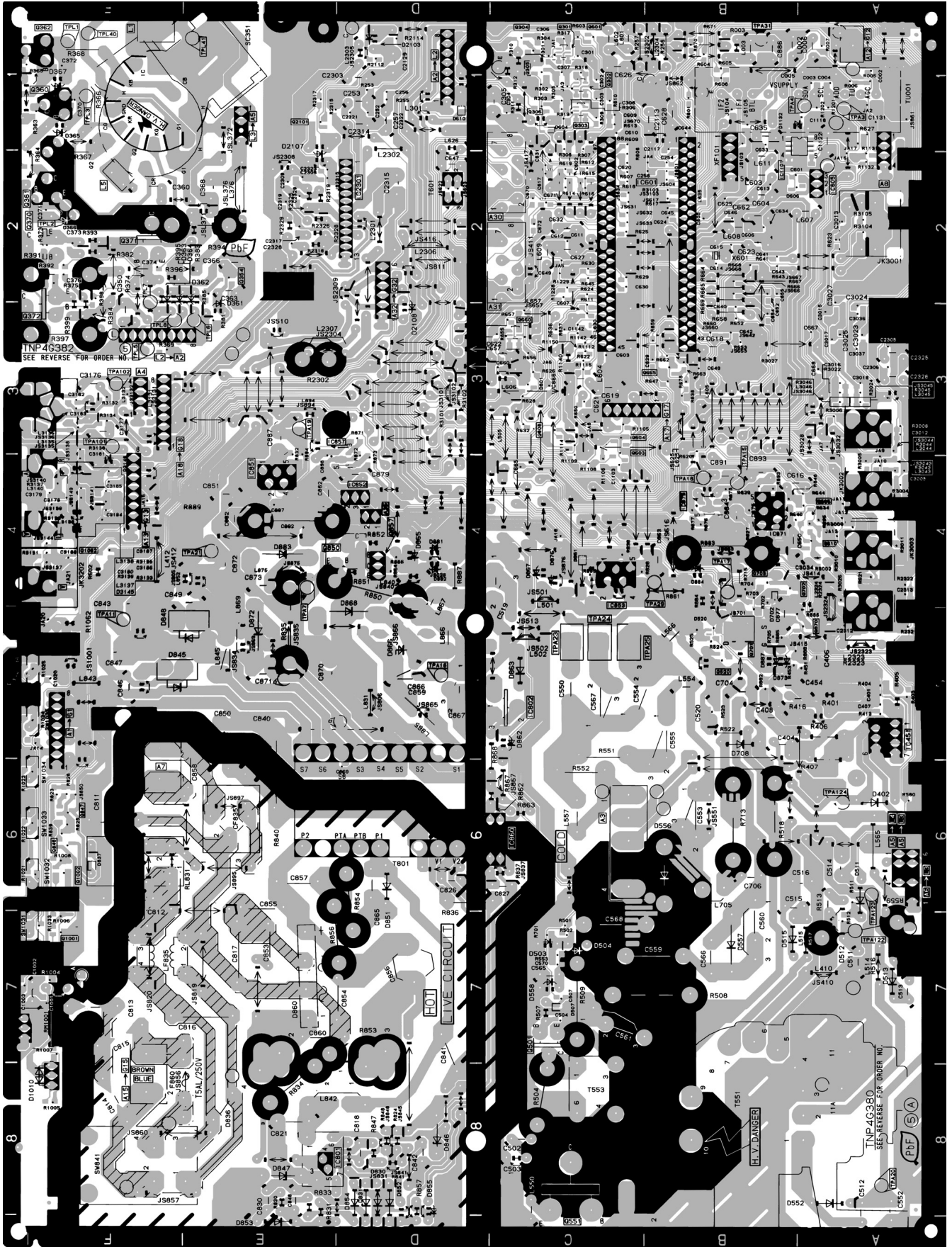

Fig. 11

Notes:

1. Wedge A, B and C should be inserted following the sequence of 1, 2 and 3 shown in Fig. 11.
2. The wedges should be set 120° apart from each other.
3. Be certain that three wedges are firmly fixed and the Deflection Yoke is tightly clamped in place. Otherwise the Deflection Yoke may shift its position and cause a loss of convergence and purity.

3 Conductor Views



4 Schematic Diagram

Important Safety Notice







Components identified by  mark have special characteristics important for safety. When replacing any of these components, use only manufacturer's specified parts.

Notes :

1. Resistor

All resistors are carbon 1/4W resistors unless marked as follows :









Unit of resistance is OHM (Ω) (K = 1 000 M = 1 000 000)

	Nonflammable		Metal Oxide
	Solid		Metal Film
	Wire Wound		Fuse

2. Capacitor

All capacitors are ceramic 50V capacitors unless marked as follows :

Unit of capacitance is μF unless otherwise noted.

	Temperature Compensation		Electrolytic
	Polyester		Bipolar
	Metalized Polyester		Dipped Tantalum
	Polypropylene		Z-Type



3. Coil

Unit of inductance is μH , unless otherwise noted.

4. Test Point

 : Test Point position

5. Earth Symbol

 : Chassis Earth (Cold)  : Line Earth (Hot)

6. Voltage Measurement

Voltage is measured using DC voltmeter.

Conditions of the measurement are the following :

Power Source..... AC AUTO 110-240V, 50/60Hz

Receiving Signal.....Colour Bar signal (RF)

All customer's controls.....Maximum positions

7. Number in red circle indicates waveform number.

(See waveform pattern table.)

8. When arrow mark (↗) is found, connection is easily found from the direction of arrow.

9. → : Indicates the major signal flow.

10. This schematic diagram is the latest at the time of printing and subject to change without notice.

Remarks :

The Power Circuit contains a circuit area which uses a separate power supply to isolate the earth connection.

The circuit is defined by HOT and COLD indications in the schematic diagram.

Take the following precautions :

All circuits, except the Power Circuit are cold.

Precautions :

- a. Do not touch the hot part or the hot and cold parts at the same time or you may be shocked.
- b. Do not short-circuit the hot and cold circuits or a fuse may blow and parts may break.
- c. Do not connect an instrument such as an oscilloscope to the hot and cold circuits simultaneously or a fuse may be blown.
Connect the earth of instruments to the earth connection of the circuit being measured.
- d. Make sure to disconnect the power plug before removing the chassis.

4.1. A Board

4.1.1. A Board (1/5)

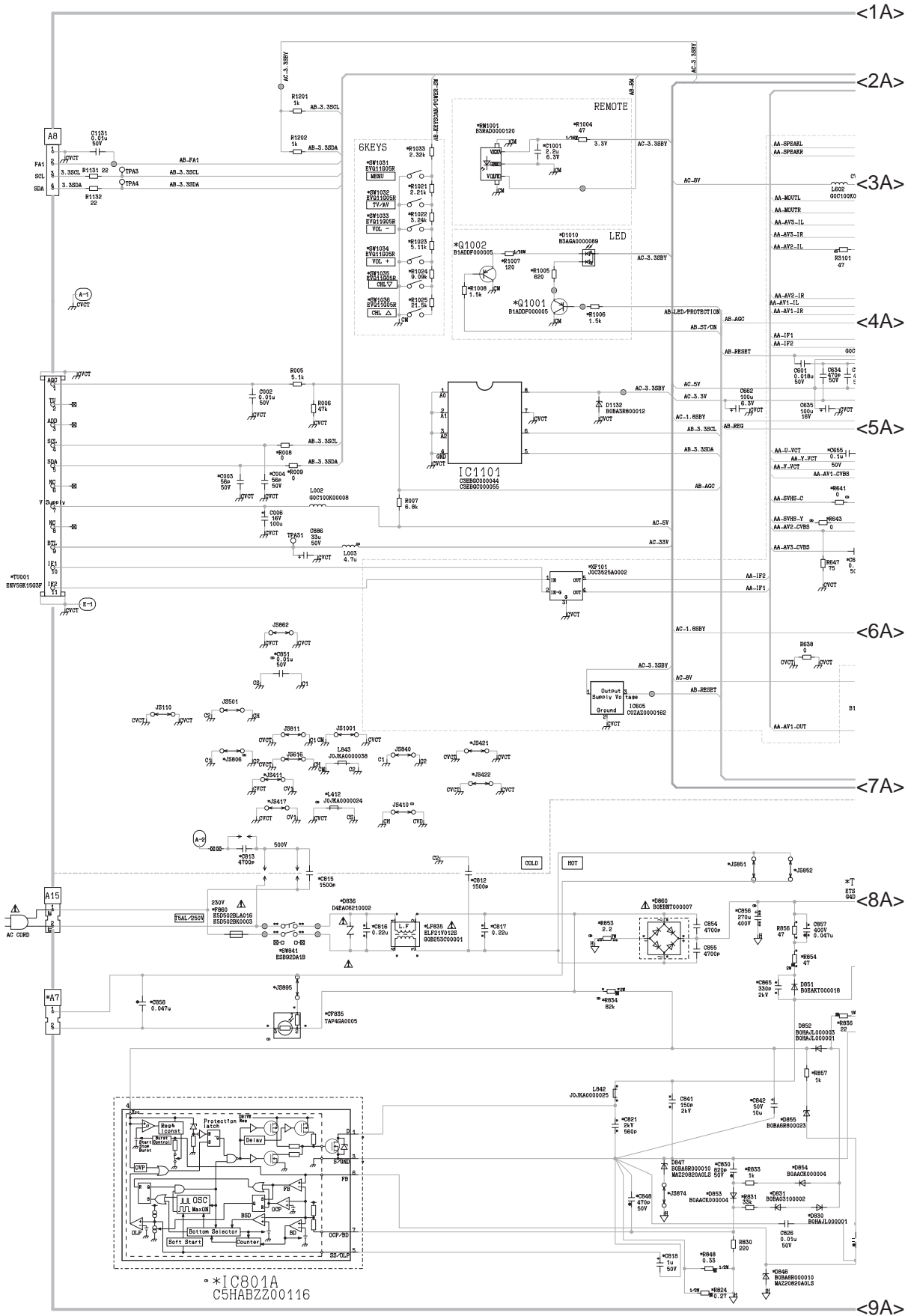

4.1.2. A Board (2/5)

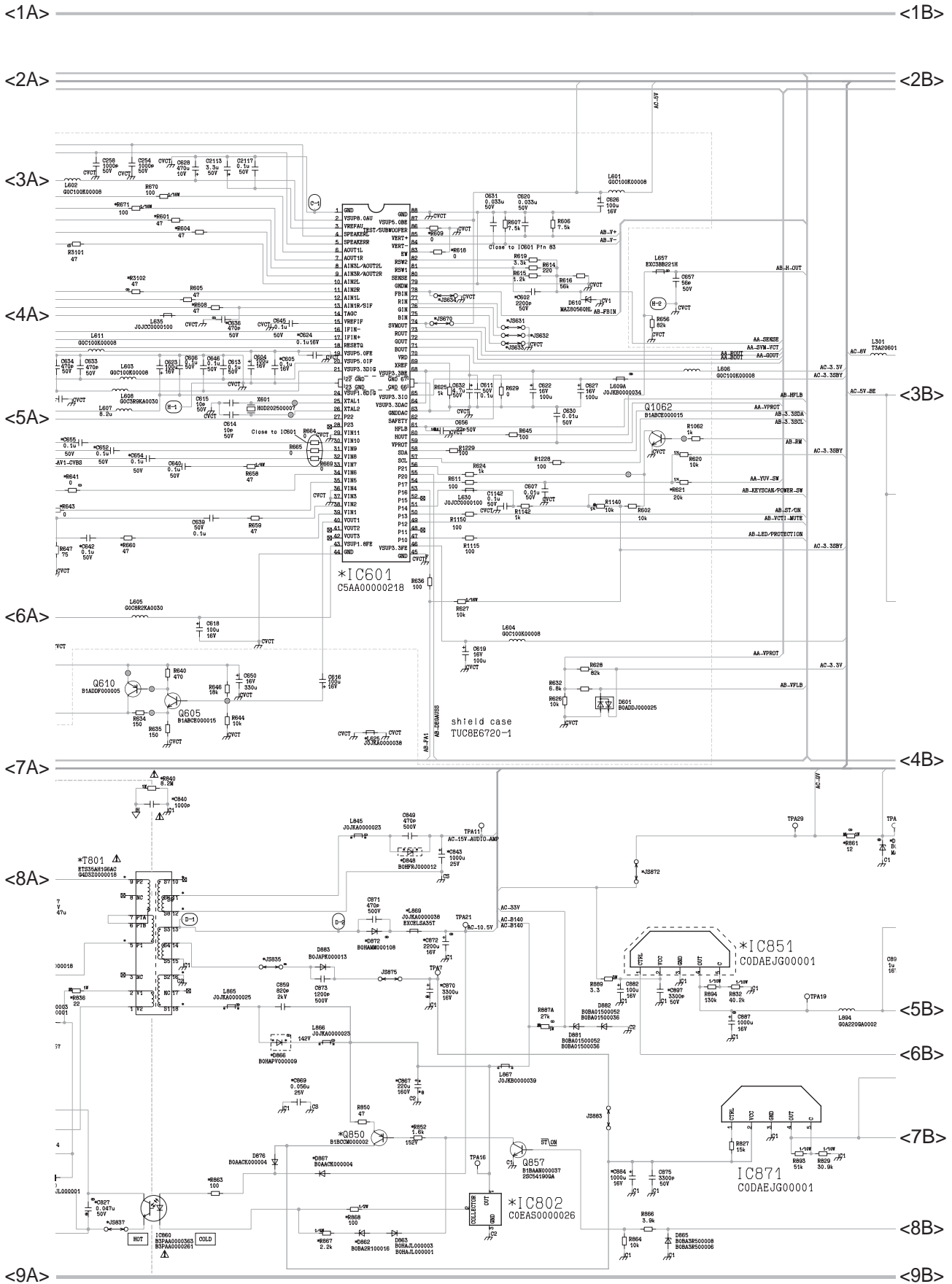

4.1.3. A Board (3/5)

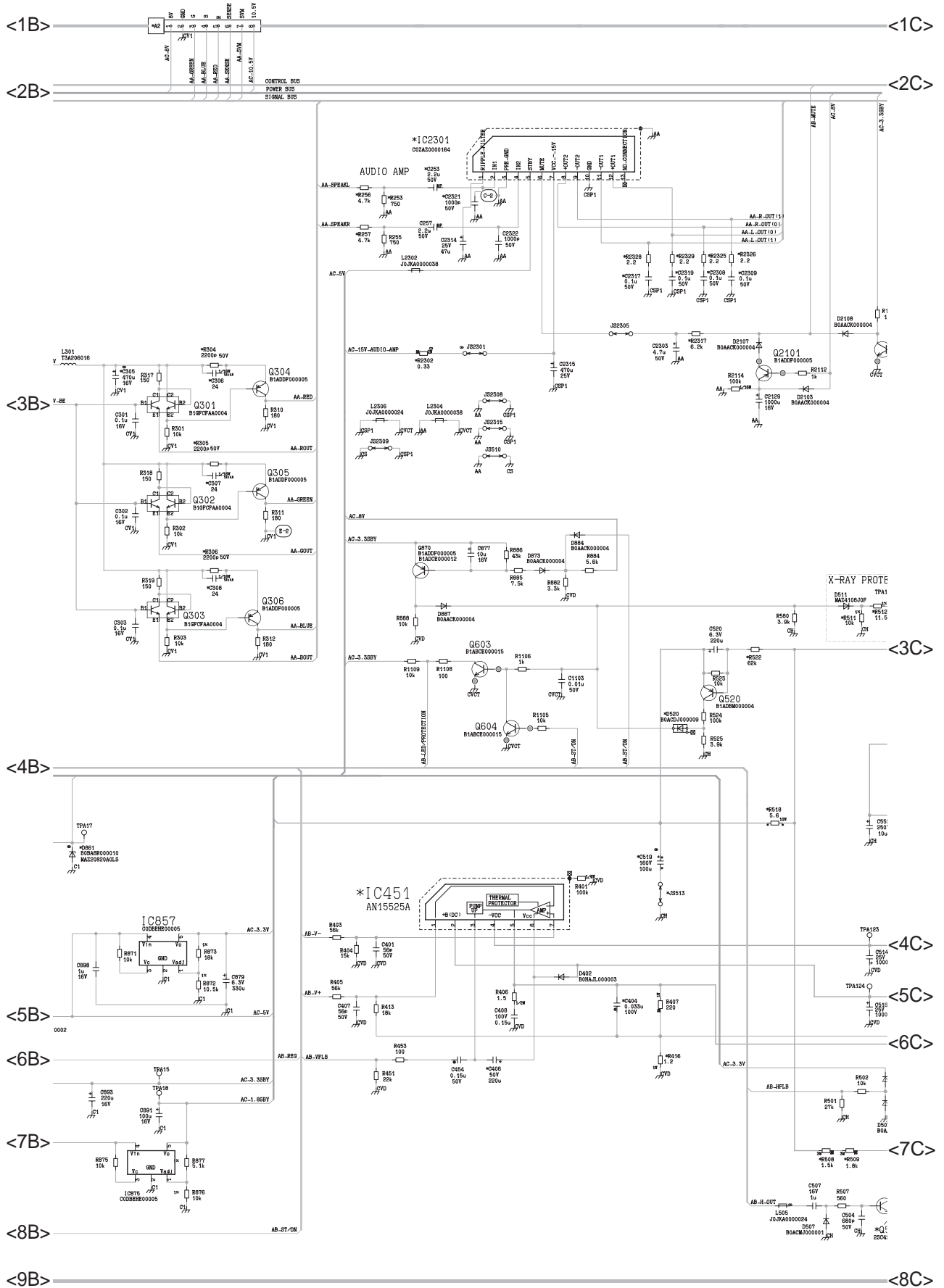

4.1.4. A Board (4/5)

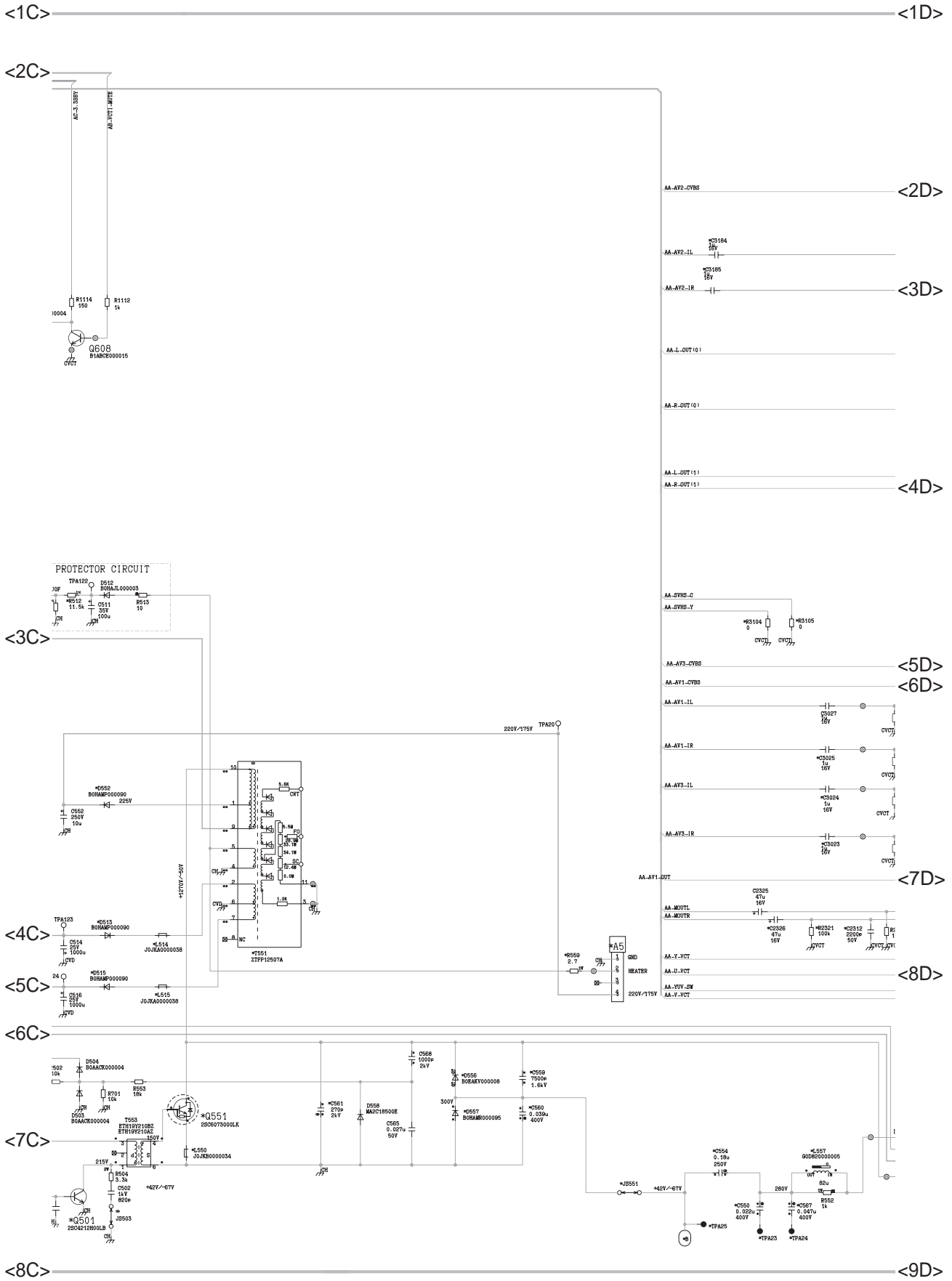

4.1.5. A Board (5/5)

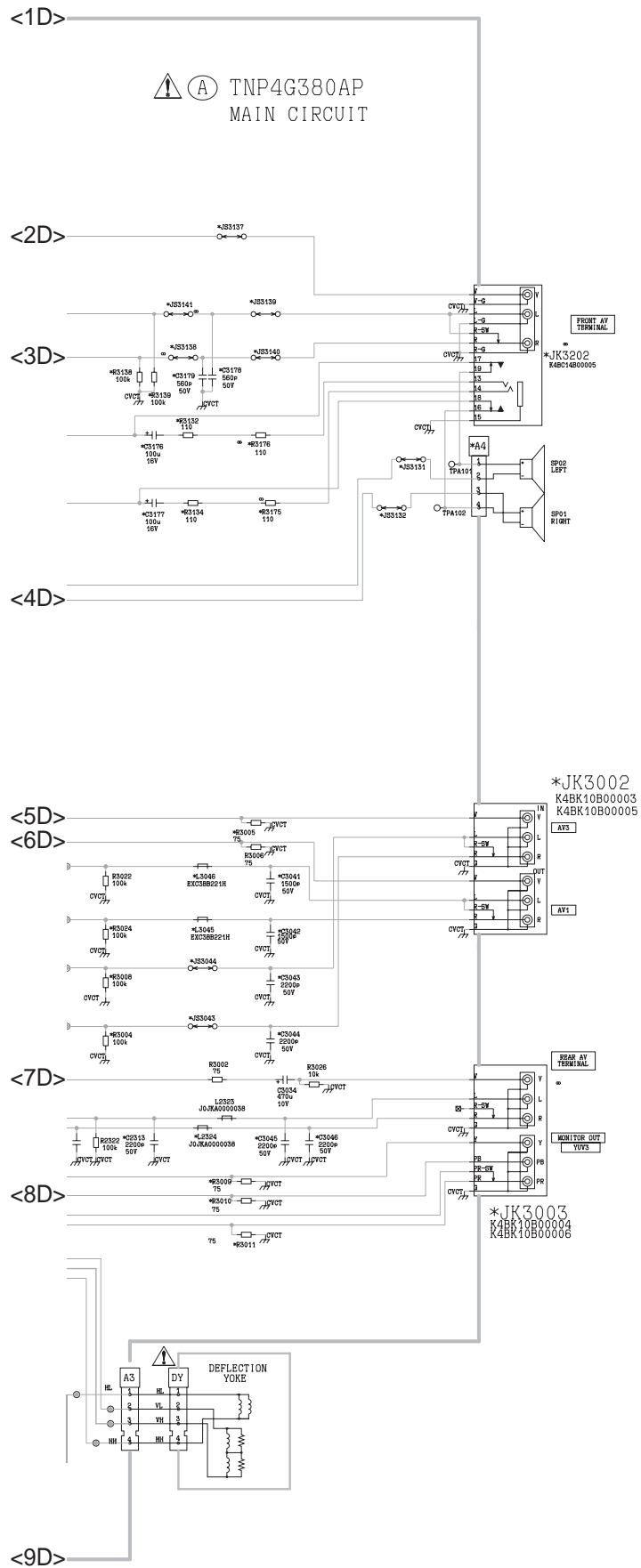

4.2. L Board

4.2.1. L Board (1/3)

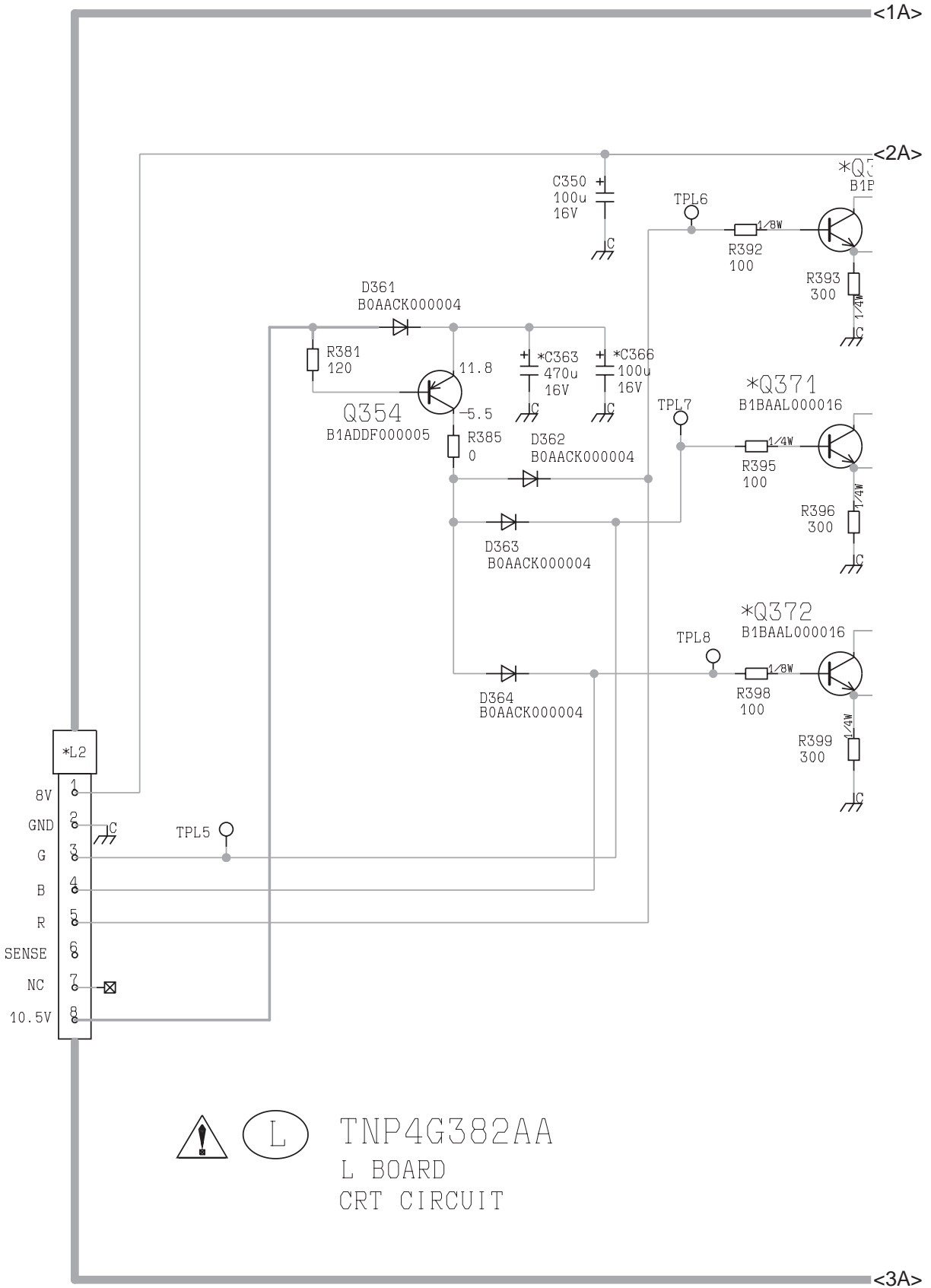

4.2.2. L Board (2/3)

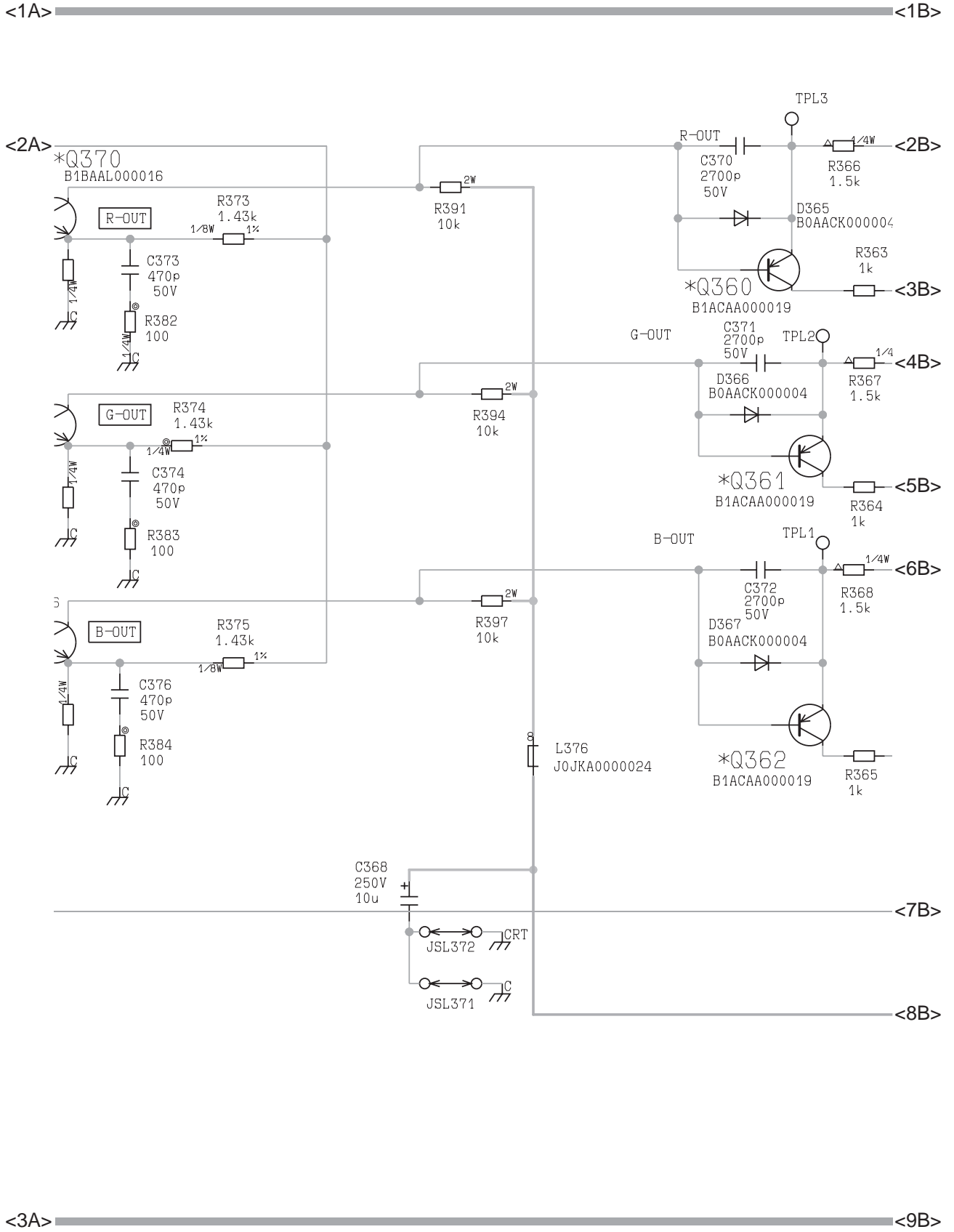

4.2.3. L Board (3/3)

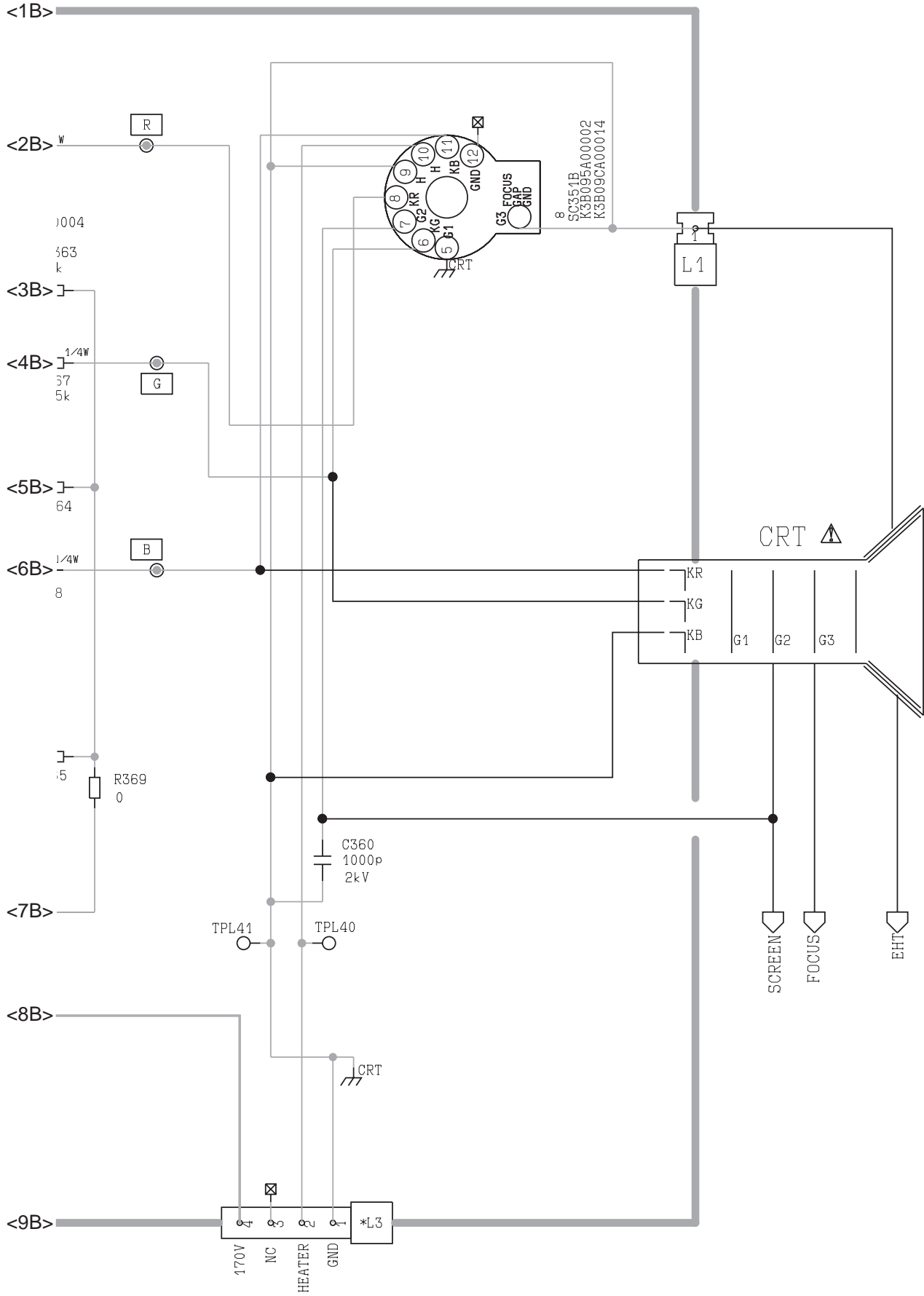

5 Parts Locations

PARTS LOCATION

Note: The number on mechanical parts indicates Ref. No. of Replacement Parts List.

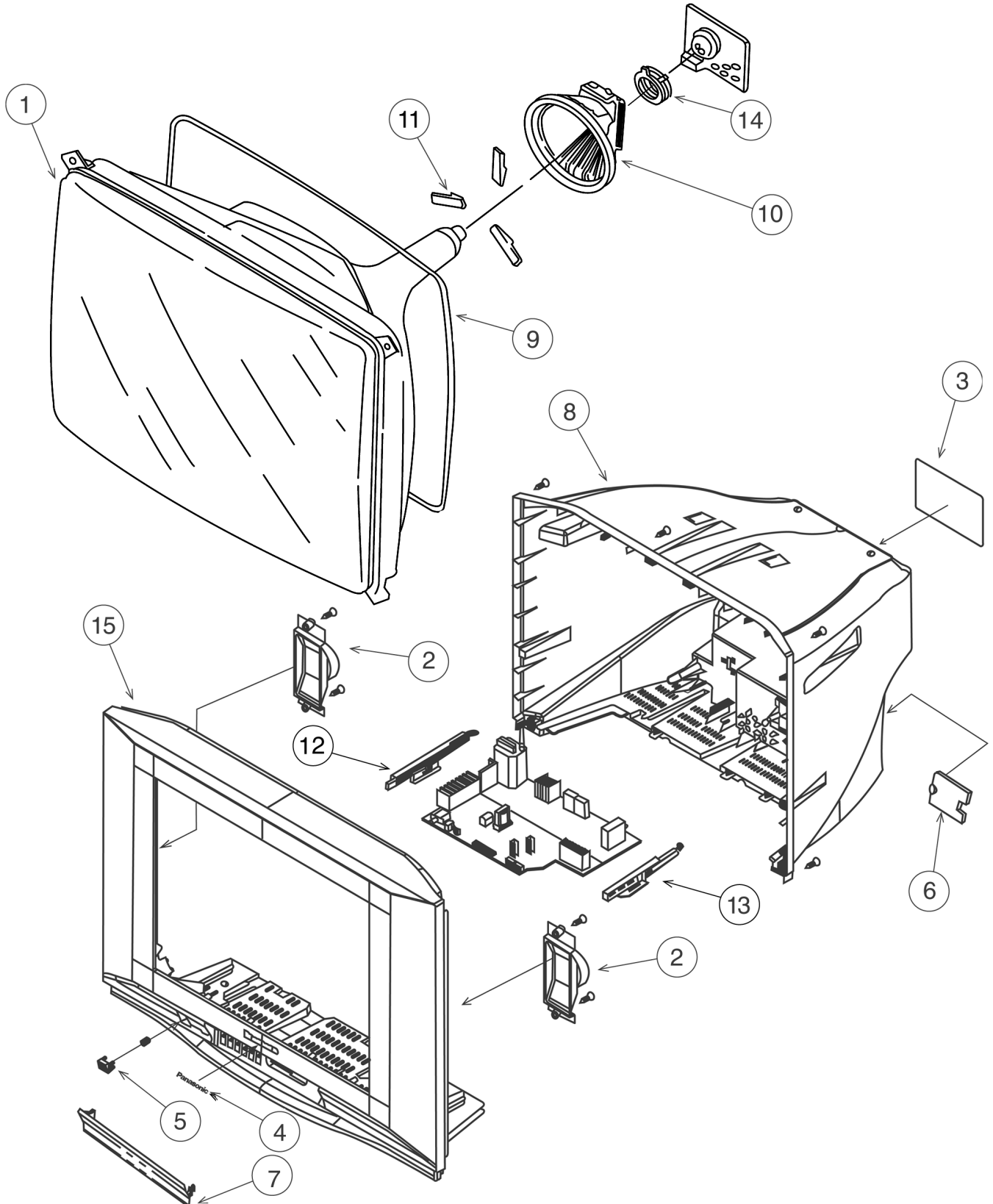

6 Replacement Parts List

Important Safety Notice

Components identified by  mark have special characteristics important for safety.
When replacing any of these components, use manufacturer's specified parts.

Note: Printed circuit board assembly with "NLA" is no longer available after production discontinuation of the complete set.

Abbreviation of part name and description

1. Resistor

Example :

ERD25TJ104 **C** 100K Ω , **J**, 1/4W
Type Allowance

Type	Allowance
C : Carbon	F : $\pm 1\%$
F : Fuse	G : $\pm 2\%$
M : Metal Oxide Metal Film	J : $\pm 5\%$ K : $\pm 10\%$
S : Solid	M : $\pm 20\%$
W : Wire Wound	

2. Capacitor

Example :

ECKF1H103ZF **C** 0.01 μ F, **Z**, 50V
Type Allowance

Type	Allowance
C : Carbon	C : $\pm 0.25\text{pF}$
E : Electrolytic	D : $\pm 0.5\text{pF}$
P : Polyester Polypropylene	F : $\pm 1\text{pF}$ G : $\pm 3\%$
T : Tantalum	J : $\pm 5\%$ K : $\pm 10\%$ L : $\pm 15\%$ M : $\pm 20\%$ P : $\pm 100\%$, -0% Z : $\pm 80\%$, -20%

6.1. Replacement Parts List

Ref. No.	Part No.	Part Name & Description	Remarks
1	A51LYZ295X	PICTURE TUBE	△
2	LOAA1C00002	SPEAKER	
	N2QAJB000161	REMOTE CONTROL	
3	TBM4G1376	MODEL NAME PLATE	△
4	TBM4G3017	PANASONIC BADGE	
5	TEX4G91101	POWER BUTTON	
	TES4G206	COIL SPRING	
	TES4G214	SPRING (POWER BUTTON)	
	TES4G409-1	SPRING (DOOR)	
	THT4G10139	SCREW	
	THT4G1014J	SCREW	
6	TKP4G11744	AC CORD BRACKET	
7	TKP4G13471	DOOR	
8	TKU4GA1351	BACK COVER	
9	TLK4G9097X	DEGAUSSING COIL	△
10	TLY4G348T	DEFLECTION YOKE	△
11	TMM4G503	RUBBER WEDGE	
12	TMZ4G9818-1	CHASSIS RAIL (L)	
13	TMZ4G9824	CHASSIS RAIL (R)	
NLA	TNP4G380AP	A BOARD	△
NLA	TNP4G382AA	L BOARD	△
14	TP-5400PW	CONVERGENCE YOKE	
	TPE4G14036	SET COVER	
	TQB4G5088	FAN BAG	
	TSMA011	MAGNET	
	TSN63115-4	PURITY MAGNET	
	TSX4G161L-1	AC POWER CORD	△
15	TXFKY01DG27	CABINET ASSY	
	TXFPC01DG27	CARTON	
	TXFPD01DG05	CUSHION (TOP)	
	TXFPD02DG04	CUSHION (BOTTOM)	
	CAPACITORS		
C002	ECJ1VF1H103Z	C 0.01UF, Z, 50V	
C003	ECJ1VC1H560J	C 56PF, J, 50V	
C004	ECJ1VC1H560J	C 56PF, J, 50V	
C006	F2A1C101A310	E 100UF, 16V	
C1001	ECJ2FB0J225K	C 2.2UF, J, 6.3V	
C1103	FLJ1H103A590	C 0.01UF, J, 50V	
C1131	FLJ1H103A590	C 0.01UF, J, 50V	
C1142	ECJ1VF1H104Z	C 0.1UF, Z, 50V	
C2113	F2A1H3R3A317	E 3.3UF, 50V	
C2117	ECJ1VF1H104Z	C 0.1UF, Z, 50V	
C2129	F2A1C102A159	E 1000UF, 16V	
C2303	F2A1H4R7A317	E 4.7UF, 50V	
C2308	ECJ1VF1H104Z	C 0.1UF, Z, 50V	
C2309	ECJ1VF1H104Z	C 0.1UF, Z, 50V	
C2314	F2A1E470A270	E 47UF, 25V	
C2315	F2A1E471A299	E 470UF, 25V	
C2317	ECJ1VF1H104Z	C 0.1UF, Z, 50V	
C2319	ECJ1VF1H104Z	C 0.1UF, Z, 50V	
C2321	FLJ1H102A018	E 1000UF, 50V	
C2322	FLJ1H102A018	E 1000UF, 50V	
C2325	F2A1C470A310	E 47UF, 16V	
C2326	F2A1C470A310	E 47UF, 16V	
C253	ECEA1HN2R2U	E 2.2UF, 50V	
C254	FLJ1H102A018	E 1000UF, 50V	
C257	ECEA1HN2R2U	E 2.2UF, 50V	
C258	FLJ1H102A018	E 1000UF, 50V	
C301	ECJ2VB1C104K	C 0.1UF, K, 16V	
C302	ECJ2VB1C104K	C 0.1UF, K, 16V	
C3023	ECJ1VF1C105Z	C 1UF, Z, 16V	
C3024	ECJ1VF1C105Z	C 1UF, Z, 16V	
C3025	ECJ1VF1C105Z	C 1UF, Z, 16V	
C3027	ECJ1VF1C105Z	C 1UF, Z, 16V	
C303	ECJ2VB1C104K	C 0.1UF, K, 16V	
C3034	F2A1A471A274	E 470UF, 10V	
C3041	ECJ2VC1H152J	C 1500PF, J, 50V	
C3042	ECJ2VC1H152J	C 1500PF, J, 50V	
C3043	ECJ2VC1H222J	C 2200PF, J, 50V	
C3044	ECJ2VC1H222J	C 2200PF, J, 50V	
C3045	ECJ2VC1H222J	C 2200PF, J, 50V	

Ref. No.	Part No.	Part Name & Description	Remarks
C3046	ECJ2VC1H222J	C 2200PF, J, 50V	
C305	F2A1C471A339	E 470UF, 16V	
C306	DOGB240JA008	F 24,J, 1/16V	
C307	DOGB240JA008	F 24,J, 1/16V	
C308	DOGB240JA008	F 24,J, 1/16V	
C3176	F2A1C101A310	E 100UF, 16V	
C3177	F2A1C101A310	E 100UF, 16V	
C3178	ECJ1VC1H561J	C 560PF, J, 50V	
C3179	ECJ1VC1H561J	C 560PF, J, 50V	
C3184	ECJ1VF1C105Z	C 1UF, J, 16V	
C3185	ECJ1VF1C105Z	C 1UF, J, 16V	
C350	ECA1CM101B	E 100UF, 16V	
C360	ECKW3D102KBP	C 1000PF, K, 2KV	
C363	F2A1C4710045	E 470UF, 16V	
C366	F2A1C101A310	E 100UF, 16V	
C368	ECA2EM100B	E 10UF, 250V	
C370	FLJ1H272A021	C 2700PF, 50V	
C371	FLJ1H272A021	C 2700PF, 50V	
C372	FLJ1H272A021	C 2700PF, 50V	
C373	ECJ1VC1H471J	C 470PF, J, 50V	
C374	ECJ1VC1H471J	C 470PF, J, 50V	
C376	ECJ1VC1H471J	C 470PF, J, 50V	
C401	ECJ1VC1H560J	C 56PF, J, 50V	
C404	ECQB1333JF	P 0.033UF, J, 100V	
C406	F2A1H221A247	E 220UF, 50V	
C407	ECJ1VC1H560J	C 56PF, J, 50V	
C408	ECQB1154JF	P 0.15UF, J, 100V	
C454	ECQV1H154JM	P 0.15UF, J, 50V	
C502	ECKR3A821KBP	C 820PF, K, 1KV	
C504	FLJ1H681A590	C 680PF, 50V	
C507	ECJ1VF1C105Z	C 1UF, Z, 16V	
C511	ECA1VM101B	E 100UF, 35V	
C514	F2A1E102A225	E 1000UF, 25V	
C516	F2A1E102A225	E 1000UF, 25V	
C519	F2A2C1010015	E 100UF, 160V	
C520	F2A0J221A317	E 220UF, 6.3V	
C550	ECQM4223JZ	P 0.022UF, J, 400V	
C552	F2A2E1000023	E 10UF, 250V	
C554	FOC2E184A039	P 0.18UF, 250V	
C559	FOC3C752A002	P 7500PF, 1.6kV	
C560	ECQM4393JZ	P 0.039UF, J, 400V	
C561	ECKW3D271JBR	C 270PF, 2kV	
C565	FOA1H273A039	C 0.027UF, 50V	
C567	ECQM4473JZ	P 0.047UF, J, 400V	
C568	FOC3D102A003	P 1000PF, 2kV	
C601	FLJ1H183A021	C 0.018UF, 50V	
C602	ECJ1VB1H222K	C 2200PF, K, 50V	
C604	F2A1C101A310	E 100UF, 16V	
C605	ECJ2VB1C104K	C 0.1UF, K, 16V	
C606	ECJ1VF1H104Z	C 0.1UF, Z, 50V	
C607	ECJ1VF1H103Z	C 0.01UF, Z, 50V	
C611	ECJ1VF1H104Z	C 0.1UF, Z, 50V	
C613	ECJ1VF1H104Z	C 0.1UF, Z, 50V	
C614	ECJ1VC1H100C	C 10PF, C, 50V	
C615	ECJ1VC1H100C	C 10PF, C, 50V	
C616	F2A1C101A310	E 100UF, 16V	
C618	F2A1C101A310	E 100UF, 16V	
C619	F2A1C101A310	E 100UF, 16V	
C620	ECJ1VB1H333K	C 0.033UF, K, 50V	
C622	F2A1C101A310	E 100UF, 16V	
C623	F2A1C101A310	E 100UF, 16V	
C624	ECJ2VB1C104K	C 0.1UF, K, 16V	
C626	F2A1C101A310	E 100UF, 16V	
C627	F2A1C101A310	E 100UF, 16V	
C628	F2A1A471A274	E 470UF, 10V	
C630	ECJ1VF1H103Z	C 0.01UF, Z, 50V	
C631	ECJ1VB1H333K	C 0.033UF, K, 50V	
C632	F2A1H4R7A317	E 4.7UF, 50V	
C633	ECJ1VC1H471J	C 470PF, J, 50V	
C634	ECJ1VC1H471J	C 470PF, J, 50V	
C635	F2A1C101A310	E 100UF, 16V	
C636	ECJ1VC1H471J	C 470PF, J, 50V	
C639	ECJ1VF1H104Z	C 0.1UF, Z, 50V	

Ref. No.	Part No.	Part Name & Description	Remarks
C640	ECJ1VF1H104Z	C 0.1UF, Z, 50V	
C642	ECJ1VF1H104Z	C 0.1UF, Z, 50V	
C645	ECJ1VF1H104Z	C 0.1UF, Z, 50V	
C646	ECJ1VF1H104Z	C 0.1UF, Z, 50V	
C650	ECA1CM331B	E 330UF, 16V	
C652	ECJ1VF1H104Z	C 0.1UF, Z, 50V	
C654	ECJ1VF1H104Z	C 0.1UF, Z, 50V	
C655	ECJ1VF1H104Z	C 0.1UF, Z, 50V	
C656	ECJ1VC1H270J	C 27PF, J, 50V	
C657	ECJ1VC1H560J	C 56PF, J, 50V	
C662	F2A0J101A317	E 4.7UF, 50V	
C812	FLA2E152A001	C 1500PF	
C813	ECKCNA472ME7	C 4700PF, M,	
C815	FLA2E152A001	C 1500PF	
C816	F0CAF2240003	CAP 250VAC 0.22UF	
C817	F0CAF2240003	CAP 250VAC 0.22UF	
C818	F2A1H1R0A317	E 1UF, 50V	
C821	ECKW3D561KBP	C 560PF, K, 2KV	
C826	F0A1H103A039	C 0.01UF, 50V	
C827	ECQB1H473JF	P 0.047UF, J, 50V	
C830	ECQB1H821KF	P 820PF, 50V	
C840	ECKCNA102MB7	C 1000PF, M,	
C841	ECKW3D151KBR	C 150PF, K, 2KV	
C842	F2A1H1000084	E 10UF, 50V	
C843	F2A1E102A223	E 1000UF, 25V	
C848	ECQB1H471JF	P 470PF, J, 50V	
C849	F1B2H471A025	C 470PF, J, 500V	
C851	F0A1H103A039	C 0.01UF, 50V	
C854	ECKWAE472ZED	C 4700PF, Z, 500V	
C855	ECKWAE472ZED	C 4700PF, Z, 500V	
C856	F2B2G2710010	E 270UF, 400V	
C857	ECQM4473JZ	P 0.047UF, J, 400V	
C858	ECQE2A473JF	P 0.047UF, J, 250V	
C859	ECKW3D821KBP	C 820PF, K, 2KV	
C865	ECKW3D331JBP	C 330PF, J, 2KV	
C867	F2A2C2210013	E 220UF, 160V	
C869	F1J1E563A003	C 0.056UF, 25V	
C870	F2A1C332A260	E 3300UF, 16V	
C871	F1B2H471A025	C 470PF, 500V	
C872	F2A1C222A117	E 2200UF, 16V	
C873	L6Y5P4B122K	C 1200PF, K, 500V	
C875	F1J1H332A021	C 3300PF, 50V	
C877	F2A1C1000079	C 10UF, 16V	
C879	F2A0J331A260	E 10UF, 16V	
C882	F2A1C101A310	E 330UF, 6.3V	
C884	F2A1C102A159	E 100UF, 16V	
C886	F2A1H330A342	E 1000UF, 16V	
C887	F2A1C102A159	E 33UF, 50V	
C890	ECJ1VB1C104K	E 1000UF, 16V	
C891	F2A1C101A310	E 100UF, 16V	
C893	F2A1C221A338	E 220UF, 16V	
C897	F1J1H332A021	C 3300PF, 50V	
C898	ECJ1VF1C105Z	C 1UF, Z, 16V	
	DIODES		
D1010	B3AGA0000089	DIODE	
D1132	B0BA3R800012	DIODE	
D2103	B0AACK000004	DIODE	
D2107	B0AACK000004	DIODE	
D2108	B0AACK000004	DIODE	
D361	B0AACK000004	DIODE	
D362	B0AACK000004	DIODE	
D363	B0AACK000004	DIODE	
D364	B0AACK000004	DIODE	
D365	B0AACK000004	DIODE	
D366	B0AACK000004	DIODE	
D367	B0AACK000004	DIODE	
D402	B0HAJL000003	DIODE	
D503	B0AACK000004	DIODE	
D504	B0AACK000004	DIODE	
D507	B0ACMJ000001	DIODE	
D511	MA4108J	DIODE	
D512	B0HAJL000003	DIODE	
D513	B0HAMP000090	DIODE	

Ref. No.	Part No.	Part Name & Description	Remarks
D515	B0HAMP000090	DIODE	
D520	B0ACDJ000009	DIODE	
D552	B0HAMP000090	DIODE	
D556	ERB06-15	DIODE	
D557	B0HAMR000095	DIODE	
D558	MA185	DIODE	
D601	B0ADDJ000025	DIODE	
D610	MAZ80560HL	DIODE	
D830	B0HAJL000001	DIODE	
D831	MTZJ33B	ZENER DIODE	
D836	D4EAC6210002	VARISTOR	
D846	B0BA8R000010	DIODE	
D847	B0BA8R000010	DIODE	
D848	FMLG12S	DIODE	
D851	B0EAKT000018	DIODE	
D852	B0HAJL000003	DIODE	
D853	B0AACK000004	DIODE	
D854	B0AACK000004	DIODE	
D855	B0BA6R800023	DIODE	
D860	B0EBNT000007	DIODE	
D861	B0BA8R000010	DIODE	
D862	MTZJ2.0B	ZENER DIODE	
D863	B0HAJL000003	DIODE	
D865	B0BA3R500008	DIODE	
D866	B0HAPV000009	DIODE	
D867	B0AACK000004	DIODE	
D872	B0HAMM000108	DIODE	
D873	B0AACK000004	DIODE	
D876	B0AACK000004	DIODE	
D881	B0BA01500052	DIODE	
D882	B0BA01500052	DIODE	
D883	B0JAPK000013	DIODE	
D884	B0AACK000004	DIODE	
D887	B0AACK000004	DIODE	
	INTEDGRATED CIRCUITS		
IC1101	TVR4GAS484	EEPROM IC	
IC2301	COZAZ0000164	IC	
IC451	AN15525A	IC	
IC601	TVR4G19-6	FLASH MEMORY IC	
IC605	COZAZ0000162	IC	
IC801	C5HABZZ00116	IC, HYBRID	△
IC802	COEAS0000026	IC	
IC851	CODAEJG000001	IC, POWER SUPPLY	
IC857	CODBEHE000005	IC, POWER SUPPLY	
IC860	B3PAA0000363	PHOTO COUPLER	
IC871	CODAEJG000001	IC, POWER SUPPLY	
IC875	CODBEHE000005	IC, POWER SUPPLY	
	COILS		
L002	G0C100K000008	COIL	
L003	G0C4R7JA0055	PEAKING COIL	
L2302	J0JKA0000038	BEAD CORE	
L2304	J0JKA0000038	BEAD CORE	
L2306	J0JKA0000024	EMI FILTER	
L2323	J0JKA0000038	BEAD CORE	
L2324	J0JKA0000038	BEAD CORE	
L3045	EXC3BB221H	CHIP BEAD CORE	
L3046	EXC3BB221H	CHIP BEAD CORE	
L376	J0JKA0000024	EMI FILTER	
L412	J0JKA0000024	EMI FILTER	
L505	J0JKA0000024	EMI FILTER	
L514	J0JKA0000038	BEAD CORE	
L515	J0JKA0000038	BEAD CORE	
L550	J0JKB0000034	EMI FILTER	
L557	G0D820000005	LINEARITY COIL	
L601	G0C100K000008	COIL	
L602	G0C100K000008	COIL	
L603	G0C100K000008	COIL	
L604	G0C100K000008	COIL	
L605	TALV35VB8R2K	PEAKING COIL	
L606	G0C100K000008	COIL	
L607	TALV35VB8R2K	PEAKING COIL	
L608	G0C3R9KA0030	PEAKING COIL	

Ref. No.	Part No.	Part Name & Description	Remarks
L609	J0JKB0000034	EMI FILTER	
L611	GOC100K00008	COIL	
L625	J0JKA0000038	BEAD CORE	
L630	TSK1032	BEAD CORE	
L635	TSK1032	BEAD CORE	
L657	EXC3BB221H	CHIP BEAD CORE	
L842	J0JKA0000025	BEAD CORE	
L843	J0JKA0000038	BEAD CORE	
L845	J0JKA0000023	BEAD CORE	
L865	J0JKA0000025	BEAD CORE	
L866	J0JKA0000023	BEAD CORE	
L867	J0JKB0000039	EMI FILTER	
L869	J0JKA0000038	BEAD CORE	
L894	G0A220GA0002	CHOKE COIL	
		TRANSISTORS	
Q1001	BIADDF000005	TRANSISTOR	
Q1002	BIADDF000005	TRANSISTOR	
Q1062	BIABCE000015	TRANSISTOR	
Q2101	BIADDF000005	TRANSISTOR	
Q301	BIGFCAA00004	TRANSISTOR	
Q302	BIGFCAA00004	TRANSISTOR	
Q303	BIGFCAA00004	TRANSISTOR	
Q304	BIADDF000005	TRANSISTOR	
Q305	BIADDF000005	TRANSISTOR	
Q306	BIADDF000005	TRANSISTOR	
Q354	BIADDF000005	TRANSISTOR	
Q360	BIACAA000019	TRANSISTOR	
Q361	BIACAA000019	TRANSISTOR	
Q362	BIACAA000019	TRANSISTOR	
Q370	B1BAAL000016	TRANSISTOR	
Q371	B1BAAL000016	TRANSISTOR	
Q372	B1BAAL000016	TRANSISTOR	
Q501	2SC4212H	TRANSISTOR	
Q520	BLADB0000004	TRANSISTOR	
Q551	2SC6073000LK	TRANSISTOR	
Q603	BIABCE000015	TRANSISTOR	
Q604	BIABCE000015	TRANSISTOR	
Q605	BIABCE000015	TRANSISTOR	
Q608	BIABCE000015	TRANSISTOR	
Q610	BIADDF000005	TRANSISTOR	
Q850	B1BCCM000002	TRANSISTOR	
Q857	B1BAAN000037	TRANSISTOR	
Q870	BIADDF000005	TRANSISTOR	
		RESISTORS	
R005	D0GB512JA008	F 5.1KOHM,J,1/16W	
R006	ERJ3GEYJ473	M 47KOHM,J,1/16W	
R007	ERJ3GEYJ682	M 6.8KOHM,J,1/16W	
R008	ERJ3GEY0R00	M 00HM,J,1/16W	
R009	ERJ3GEY0R00	M 00HM,J,1/16W	
R1004	ERJ3GEYJ470	M 47OHM,J,1/16W	
R1005	ERJ3GEYJ621	M 620OHM,J,1/16W	
R1006	ERJ3GEYJ152	M 1.5KOHM,J,1/16W	
R1007	ERJ3GEYJ121	M 120OHM,J,1/16W	
R1008	ERJ3GEYJ152	M 1.5KOHM,J,1/16W	
R1021	ERJ3EKF2211	M2.21KOHM,F,1/16W	
R1022	ERJ3EKF3241	M3.24KOHM,F,1/16W	
R1023	ERJ3EKF5111	M5.11KOHM,F,1/16W	
R1024	ERJ3EKF9091	M9.09KOHM,F,1/16W	
R1025	ERJ3EKF2152	M21.5KOHM,F,1/16W	
R1033	ERJ3EKF2321	M2.32KOHM,F,1/16W	
R1062	ERDS2TJ102	C 1KOHM,J,1/4W	
R1105	ERJ3GEYJ103	M 10KOHM,J,1/16W	
R1106	ERJ3GEYJ102	M 1KOHM,J,1/16W	
R1108	ERJ3GEYJ101	M 100OHM,J,1/16W	
R1109	ERJ3GEYJ103	M 10KOHM,J,1/16W	
R1112	ERJ3GEYJ102	M 1KOHM,J,1/16W	
R1114	ERJ3GEYJ151	M 150OHM,J,1/16W	
R1115	ERJ3GEYJ101	M 100OHM,J,1/16W	
R1131	ERJ3GEYJ220	M 220OHM,J,1/16W	
R1132	ERJ3GEYJ220	M 220OHM,J,1/16W	
R1140	ER0S2CKF1002	M 10KOHM,F,1/4W	
R1142	ERJ3EKF1001	M 1KOHM,F,1/16W	
R1150	ERJ3GEYJ101	M 100OHM,J,1/16W	

Ref. No.	Part No.	Part Name & Description	Remarks
R1201	ERJ3GEYJ102	M 1KOHM,J,1/16W	
R1202	ERJ3GEYJ102	M 1KOHM,J,1/16W	
R1228	ERJ3GEYJ101	M 100OHM,J,1/16W	
R1229	ERJ3GEYJ101	M 100OHM,J,1/16W	
R2112	ERJ3GEYJ102	M 1KOHM,J,1/16W	
R2114	ERJ3GEYJ104	M 100KOHM,J,1/16W	
R2302	ERX2FJSR33E	C 0.33OHM,J, 2W	
R2317	D0GB622JA008	F 6.2KOHM,J,1/16W	
R2321	ERJ3GEYJ104	M 100KOHM,J,1/16W	
R2322	ERJ3GEYJ104	M 100KOHM,J,1/16W	
R2325	D0AE2R2JA046	C 2.2OHM,J, 1/4W	
R2326	D0AE2R2JA046	C 2.2OHM,J, 1/4W	
R2328	D0AE2R2JA046	C 2.2OHM,J, 1/4W	
R2329	D0AE2R2JA046	C 2.2OHM,J, 1/4W	
R253	D0GB751JA008	F 750OHM,J,1/16W	
R255	D0GB751JA008	F 750OHM,J,1/16W	
R256	ERDS2TJ472	C 4.7KOHM,J, 1/4W	
R257	ERDS2TJ472	C 4.7KOHM,J, 1/4W	
R3002	ERJ3GEYJ750	M 750OHM,J,1/16W	
R3004	ERJ3GEYJ104	M 100KOHM,J,1/16W	
R3005	ERJ3GEYJ750	M 750OHM,J,1/16W	
R3006	ERJ3GEYJ750	M 750OHM,J,1/16W	
R3008	ERJ3GEYJ104	M 100KOHM,J,1/16W	
R3009	ERJ3GEYJ750	M 750OHM,J,1/16W	
R301	ERJ3GEYJ103	M 10KOHM,J,1/16W	
R3010	ERJ3GEYJ750	M 750OHM,J,1/16W	
R3011	ERJ3GEYJ750	M 750OHM,J,1/16W	
R302	ERJ3GEYJ103	M 10KOHM,J,1/16W	
R3022	ERJ3GEYJ104	M 100KOHM,J,1/16W	
R3024	ERJ3GEYJ104	M 100KOHM,J,1/16W	
R3026	ERJ3GEYJ103	M 10KOHM,J,1/16W	
R303	ERJ3GEYJ103	M 10KOHM,J,1/16W	
R304	ECJ1VB1H222K	C 2200PF, K, 50V	
R305	ECJ1VB1H222K	C 2200PF, K, 50V	
R306	ECJ1VB1H222K	C 2200PF, K, 50V	
R310	D0AE181JA046	C 180OHM,J, 1/4W	
R3101	ERDS2TJ470	C 47OHM,J, 1/4W	
R3102	ERDS2TJ470	C 47OHM,J, 1/4W	
R3104	ERJ3GEY0R00	M 00HM,J,1/16W	
R3105	ERJ3GEY0R00	M 00HM,J,1/16W	
R311	D0AE181JA046	C 180OHM,J, 1/4W	
R312	D0AE181JA046	C 180OHM,J, 1/4W	
R3132	D0GB111JA008	F 110OHM,J,1/16W	
R3134	D0GB111JA008	F 110OHM,J,1/16W	
R3138	ERJ3GEYJ104	M 100KOHM,J,1/16W	
R3139	ERJ3GEYJ104	M 100KOHM,J,1/16W	
R317	ERJ3GEYJ151	M 150OHM,J,1/16W	
R3175	D0GB111JA008	F 110OHM,J,1/16W	
R3176	D0GB111JA008	F 110OHM,J,1/16W	
R318	ERJ3GEYJ151	M 150OHM,J,1/16W	
R319	ERJ3GEYJ151	M 150OHM,J,1/16W	
R363	ERJ3GEYJ102	M 1KOHM,J,1/16W	
R364	ERJ3GEYJ102	M 1KOHM,J,1/16W	
R365	ERJ3GEYJ102	M 1KOHM,J,1/16W	
R366	ERC14GK152	S 1.5KOHM, 1/4W	
R367	ERC14GK152	S 1.5KOHM, 1/4W	
R368	ERC14GK152	S 1.5KOHM, 1/4W	
R369	ERJ3GEY0R00	M 00HM,J,1/16W	
R373	ERJ3EKF1431	F 1.43KOHM, 1/8W	
R374	ER0S2CHF1431	M 1.43KOHM, 1/4W	
R375	ERJ3EKF1431	F 1.43KOHM, 1/8W	
R381	ERJ3GEYJ121	M 120OHM,J,1/16W	
R382	ER0S2CHF1000	M 100OHM,1/10W	
R383	ER0S2CHF1000	M 100OHM,1/10W	
R384	ER0S2CHF1000	M 100OHM,1/10W	
R385	ERJ3GEY0R00	M 00HM,J,1/16W	
R391	ERG2FJ103H	M 10KOHM,J, 2W	
R392	ERJ3GEYJ101	M 100OHM,J,1/16W	
R393	D0AE301JA046	C 300OHM,J, 1/4W	
R394	ERG2FJ103H	M 10KOHM,J, 2W	
R395	ERDS2TJ101	C 100OHM,J, 1/4W	
R396	D0AE301JA046	C 300OHM,J, 1/4W	
R397	ERG2FJ103H	M 10KOHM,J, 2W	

Ref. No.	Part No.	Part Name & Description	Remarks
R398	ERJ3GEYJ101	M 100OHM,J,1/16W	
R399	D0AE30LJA046	C 300OHM,J, 1/4W	
R401	ERDS2TJ104	C 100KOHM,J, 1/4W	
R403	ERJ3GEYJ563	M 56KOHM,J,1/16W	
R404	ERJ3GEYJ153	M 15KOHM,J,1/16W	
R405	ERDS2TJ563	C 56KOHM,J, 1/4W	
R406	ERDS1TJ1R5	C 1.5OHM,J, 1/2W	
R407	ERGLS221E	M 220OHM,J, 1W	
R413	ERJ3GEYJ183	M 18KOHM,J,1/16W	
R416	ERX1SJR2E	M 1.2OHM,J, 1W	
R451	ERJ3GEYJ223	M 22KOHM,J,1/16W	
R453	ERJ3GEYJ101	M 100OHM,J,1/16W	
R501	ERJ3GEYJ273	M 27KOHM,J,1/16W	
R502	ERJ3GEYJ103	M 10KOHM,J,1/16W	
R504	ERG2SJS332H	M 10KOHM,J,1/10W	
R507	ERDS2TJ561	C 560OHM,J, 1/4W	
R508	ERG3FJ152H	M 1.5KOHM,J, 3W	
R509	ERG3FJ182H	M 1.8KOHM,J, 3W	
R511	ERJ3EKF1002	M 10KOHM,F,1/16W	
R512	ERJ3EKF1152	F 11.5KOHM,J, 1/10W	
R513	ERQ14AJ100E	F 10OHM,J, 1/4W	
R518	D0DK5R6JA019	W 5.6KOHM,J,10W	
R522	D0AE623JA046	C 62KOHM,J, 1/4W	
R523	ERJ3GEYJ103	M 10KOHM,J,1/16W	
R524	ERDS2TJ104	C 100KOHM,J, 1/4W	
R525	ERJ3GEYJ392	M 3.9KOHM,J,1/16W	
R552	ERGLS2102P	M 1KOHM,J, 1W	
R553	ERJ3GEYJ183	M 18KOHM,J,1/16W	
R559	D0C12R7JA042	M 2.7OHM,J, 1W	
R580	ERJ3GEYJ392	M 3.9KOHM,J,1/16W	
R601	ERJ3GEYJ470	M 47OHM,J,1/16W	
R602	ERDS2TJ103	C 10KOHM,J, 1/4W	
R604	ERJ3GEYJ470	M 47OHM,J,1/16W	
R605	ERJ3GEYJ470	M 47OHM,J,1/16W	
R606	ERJ3GEYJ752	M 7.5KOHM,J,1/16W	
R607	ERJ3GEYJ752	M 7.5KOHM,J,1/16W	
R608	ERJ3GEYJ470	M 47OHM,J,1/16W	
R609	ERJ3GEY0R00	M 0OHM,J,1/16W	
R611	ERJ3GEYJ101	M 100OHM,J,1/16W	
R614	ERJ3GEYJ221	M 220OHM,J,1/16W	
R615	ERJ3GEYJ122	M 1.2KOHM,J,1/16W	
R616	ERJ3GEYJ563	M 56KOHM,J,1/16W	
R618	ERJ3GEY0R00	M 0OHM,J,1/16W	
R619	ERJ3GEYJ332	M 3.3KOHM,J,1/16W	
R620	ERJ3EKF1002	M 10KOHM,F,1/16W	
R621	ERJ3EKF2002	M 20KOHM, 1/10W	
R624	ERJ3GEYJ102	M 1KOHM,J,1/16W	
R625	ERJ3GEYJ102	M 1KOHM,J,1/16W	
R626	ERJ3GEYJ103	M 10KOHM,J,1/16W	
R627	ERJ3GEYJ103	M 10KOHM,J,1/16W	
R628	ERJ3GEYJ823	M 82KOHM,J,1/16W	
R629	ERJ3GEY0R00	M 0OHM,J,1/16W	
R632	ERJ3GEYJ682	M 6.8KOHM,J,1/16W	
R634	ERJ3GEYJ151	M 150OHM,J,1/16W	
R635	ERJ3GEYJ151	M 150OHM,J,1/16W	
R636	ERJ3GEYJ101	M 100OHM,J,1/16W	
R638	ERJ3GEY0R00	M 0OHM,J,1/16W	
R640	ERJ3GEYJ471	M 470OHM,J,1/16W	
R641	ERJ3GEY0R00	M 0OHM,J,1/16W	
R643	ERJ3GEY0R00	M 0OHM,J,1/16W	
R644	ERJ3GEYJ103	M 10KOHM,J,1/16W	
R645	ERJ3GEYJ101	M 100OHM,J,1/16W	
R646	ERJ3GEYJ183	M 18KOHM,J,1/16W	
R647	ERJ3GEYJ750	M 75OHM,J,1/16W	
R656	ERJ3GEYJ823	M 82KOHM,J,1/16W	
R658	ERDS2TJ470	C 47OHM,J, 1/4W	
R659	ERJ3GEYJ470	M 47OHM,J,1/16W	
R660	ERJ3GEYJ470	M 47OHM,J,1/16W	
R664	ERDS2T0T	C 0OHM, 1/4W	
R665	ERDS2T0T	C 0OHM, 1/4W	
R669	ERDS2T0T	C 0OHM, 1/4W	
R670	ERJ3GEYJ101	M 100OHM,J,1/16W	
R671	ERJ3GEYJ101	M 100OHM,J,1/16W	

Ref. No.	Part No.	Part Name & Description	Remarks
R701	ERJ3GEYJ103	M 10KOHM,J,1/16W	
R824	ERX12SJR27E	M 0.27OHM,J, 1/2W	
R827	ERJ3GEYJ153	M 15KOHM,J,1/16W	
R829	ERJ3EKF3092	F 30.9KOHM, 1/8W	
R830	ERDS2TJ221	C 220OHM,J, 1/4W	
R831	ERDS2TJ333	C 33KOHM,J, 1/4W	
R832	ERJ3EKF4022	M 40.2KOHM,J,1/10W	
R833	ERDS2TJ102	C 1KOHM,J, 1/4W	
R834	ERG2FJ823H	M 82KOHM,J,2W	
R836	ERGLS220P	M 22OHM,J,1W	
R840	RCR100TAJ825	C 8.2MOHM,J, 1W	
R848	ERX12SJR33E	M 0.33OHM,J, 1/2W	
R850	ERG3SJS470H	M 47OHM,J, 1/2W	
R852	D0AE162JA046	C 1.6KOHM,J, 152W	
R853	D0D72R2KA002	W 2.2OHM,K, 7W	△
R854	ERG2FJ470H	M 47OHM,J, 2W	
R856	ERG2SJS104H	M 100KOHM,J, 2W	
R857	ERDS2TJ102	C 1KOHM,J, 1/4W	
R861	ERGLS2120P	M 12OHM,J, 1W	
R863	ERDS2TJ101	C 100OHM,J, 1/4W	
R864	ERJ3GEYJ103	M 10KOHM,J,1/16W	
R866	ERJ3GEYJ392	M 3.9KOHM,J,1/16W	
R867	ERDS2TJ222	C 2.2KOHM,J, 1/4W	
R868	ERDS1TJ101	C 100OHM,J, 1/2W	
R871	ERJ3GEYJ103	M 10KOHM,J,1/16W	
R872	ERJ3EKF1052	F 10.5KOHM, 1/10W	
R873	ERJ3EKF1802	M 18KOHM,F,1/16W	
R875	ERJ3GEYJ103	M 10KOHM,J,1/16W	
R876	ERJ3EKF1002	M 10KOHM,F,1/16W	
R877	ERJ3EKF5101	F 5.1KOHM, 1/10W	
R882	ERJ3GEYJ332	M 3.3KOHM,J,1/16W	
R884	ERDS2TJ562	C 5.6KOHM,J, 1/4W	
R885	ERJ3GEYJ752	M 7.5KOHM,J,1/16W	
R886	D0GB433JA008	F 43KOHM, 1/10W	
R887	ERGLS273P	M 27KOHM,J, 1W	
R888	ERJ3GEYJ103	M 10KOHM,J,1/16W	
R889	ERX3FJ3R3H	M 3.3OHM,J, 3W	
R893	ERJ3EKF5102	M 51KOHM, 1/10W	
R894	ERJ3EKF1303	M 130KOHM, 1/10W	
		TRANSFORMERS	
T551	ZTFP12507A	FLYBACK TRANS	△
T553	ETH19Y210BZ	H DRIVE TRANS	△
T801	ETS35AH1G6AC	SWITCHING TRANS	△
		OTHERS	
A2	K1KA13A00140	CONNECTOR	
A4	K1KA04AA0190	CONNECTOR	
A5	K1KA04AA0190	CONNECTOR	
A8	K1KA04AA0093	CONNECTOR	
CF835	TAP4GA0005	POSISTOR	△
F860	K5D502BLA016	FUSE	△
JA1	ERJ3GEY0R00	M 0OHM,J,1/16W	
JA10	ERJ3GEY0R00	M 0OHM,J,1/16W	
JA11	ERJ3GEY0R00	M 0OHM,J,1/16W	
JA12	ERJ3GEY0R00	M 0OHM,J,1/16W	
JA13	ERJ3GEY0R00	M 0OHM,J,1/16W	
JA14	ERJ3GEY0R00	M 0OHM,J,1/16W	
JA16	ERJ3GEY0R00	M 0OHM,J,1/16W	
JA17	ERJ3GEY0R00	M 0OHM,J,1/16W	
JA2	ERJ3GEY0R00	M 0OHM,J,1/16W	
JA3	ERJ3GEY0R00	M 0OHM,J,1/16W	
JA4	ERJ3GEY0R00	M 0OHM,J,1/16W	
JA5	ERJ3GEY0R00	M 0OHM,J,1/16W	
JA6	ERJ3GEY0R00	M 0OHM,J,1/16W	
JA7	ERJ3GEY0R00	M 0OHM,J,1/16W	
JA8	ERJ3GEY0R00	M 0OHM,J,1/16W	
JA9	ERJ3GEY0R00	M 0OHM,J,1/16W	
JK3002	K4BK10B00003	REAR AV TERMINAL	
JK3003	K4BK10B00004	REAR AV TERMINAL	
JK3202	K4BC14B00005	FRONT AV TERMINAL	
JS110	ERJ3GEY0R00	M 0OHM,J,1/16W	
JS2315	ERJ3GEY0R00	M 0OHM,J,1/16W	
JS3043	ERJ3GEY0R00	M 0OHM,J,1/16W	
JS3044	ERJ3GEY0R00	M 0OHM,J,1/16W	

Ref. No.	Part No.	Part Name & Description	Remarks
JS3131	ERJ3GEY0R00	M 00HM,J,1/16W	
JS3132	ERJ3GEY0R00	M 00HM,J,1/16W	
JS3137	ERJ3GEY0R00	M 00HM,J,1/16W	
JS3139	ERJ3GEY0R00	M 00HM,J,1/16W	
JS3140	ERJ3GEY0R00	M 00HM,J,1/16W	
JS631	ERJ3GEY0R00	M 00HM,J,1/16W	
JS632	ERJ3GEY0R00	M 00HM,J,1/16W	
JS633	ERJ3GEY0R00	M 00HM,J,1/16W	
JS634	ERJ3GEY0R00	M 00HM,J,1/16W	
JS670	ERJ3GEY0R00	M 00HM,J,1/16W	
L2	K1KA13A00140	CONNECTOR	
L3	K1KA04AA0190	CONNECTOR	
LF835	ELF21V012S	LINE FILTER	
RM1001	B3RAD0000120	REMOCON RECEIVER	
SC351	K3B09CA00014	CRT SOCKET	△
SW1031	EVQ11G05R	SWITCH	
SW1032	EVQ11G05R	SWITCH	
SW1033	EVQ11G05R	SWITCH	
SW1034	EVQ11G05R	SWITCH	
SW1035	EVQ11G05R	SWITCH	
SW1036	EVQ11G05R	SWITCH	
SW841	ESB92DA1B	SWITCH	△
TU001	ENV59K15G3RF	TUNER	△
X601	H0D202500007	CRYSTAL OSC	
XF101	J0C3525A0002	DELAY LINE	△